

Gas Analyzers

NDIR / Laser / Zirconia / Paramagnetic / Thermal Conductivity

Dependable analyzers offered through long experience and with advanced technologies



Product Variety to Meet Your Needs

NDIR Gas Analyzer Systems ▶ P. 4-5

Monitors up to 7 gas components

Long-term superior stability

Applications

Waste incinerators, boilers

NOx SO₂ CO₂ CO O₂ HCl Dust



NDIR Gas Analyzers ▶ P. 6-7

Simultaneous and continuous measurement of up to 5 components

Long-term stability for wide measurement range

Applications

Steel plants (converter furnaces, blast furnaces), gas manufacturing facilities

NOx SO₂ CO₂ CO CH₄ O₂



NDIR Gas Analyzer for heat treatment furnace ▶ P. 8

Simultaneously and continuously measures 2 components among CO₂, CO, and CH₄

Applications

Heat treatment furnaces (gas generators, carburizing furnaces)

CO₂ CO CH₄



Compact NDIR Gas Analyzers ▶ P. 9

Gas sampling devices incorporated

Simultaneous measurement of up to 5 components

Applications

Chemical labs, plant labs

NOx SO₂ CO₂ CO CH₄ O₂



Laser Gas Analyzers ▶ P. 10-11

Fast measurement with insertion type sensor
Reduced cost of ownership

Applications

Waste incinerators, large industrial boilers, chemical plants

NH₃ HCl O₂ CO CO₂ CH₄



Zirconia Oxygen Analyzers ▶ P. 12-13

Ideal for combustion management
Fast response with no need for gas sampling devices

Ex-proof

Applications

Boilers, incinerators, industrial furnaces, petrochemical plants

O₂



Paramagnetic Oxygen Analyzers ▶ P. 14

Non-contact sensor offers long-term superior stability
Fast response ideal for combustible gas measurement

Applications

Incinerators, industrial furnaces

O₂



Thermal Conductivity Gas Analyzer ▶ P. 15

Reliable and continuous measurement of H₂, He, Ar, etc.

Applications

Semiconductor manufacturing facilities, industrial gas generating facilities, H₂ gas related facilities

He Ar H₂ CH₄ CO₂



NDIR Gas Analyzers (for replacement) ▶ P. 16

Designed for ease of replacement



Gas Sampling Devices ▶ P. 17



NDIR Gas Analyzer Systems

Monitors up to 7 gas components
Long-term superior stability

Simultaneous measurement of up to 5 components in flue gas

NO_x SO₂ CO₂ CO O₂

ZSJ

Japanese type approval
SAS131 (SO₂ analyzer)
SAC131 (CO analyzer)
SAN131 (NO_x analyzer)
SE981 (zirconia O₂ analyzer)
SF011 (paramagnetic O₂ analyzer)



Features

- Single-beam NDIR
- Long-term superior stability
- Sample switching system ensures zero-point stability
- Automatic calibration
- Space-saving design that enables the maintenance work from front side

Specifications

Target	Flue gas from incinerators and boilers
Measurable components	NO _x , SO ₂ , CO ₂ , CO, O ₂
Principle	Single-beam NDIR + zirconia or paramagnetic O ₂ sensor
Measurement range	NO _x : 0 ... 50 ... 5000 ppm
	SO ₂ : 0 ... 50 ... 5000 ppm
	CO ₂ : 0 ... 10% / 0 ... 20%
	CO: 0 ... 50 ... 5000 ppm
	O ₂ : 0 ... 10 vol% / 0 ... 25 vol%
Repeatability	±0.5% FS
Linearity	±1% FS
Zero drift	±1% FS per week (O ₂ : ±2% FS per month)
Span drift	±2% FS per week (O ₂ : ±2% FS per month)
Response time	NO _x , CO ₂ , CO, O ₂ : 2 min, SO ₂ : 4 min (for 90% response, from the analyzer inlet)
Output signal	4–20 mA DC
Contact output	During auto calibration, during maintenance, concentration alarm, CO peak count alarm, range identification, etc.
Contact input	Auto calibration start, range switchover, pump on/off, etc.
Functions	Auto calibration, O ₂ correction, O ₂ corrected average value, concentration alarm, CO peak count alarm, etc.
Display	Backlit LCD
Recorder	Paperless recorder (option)
Standard gas	Six 3.4L cylinders can be housed (option)
Power supply voltage	100, 110, 115, 200, or 230 V AC, 50/60 Hz
Dimensions	815 (W) × 1780 (H) × 700 (D) mm, outdoor use

Simultaneous measurement of up to 5 components in flue gas

NO_x SO₂ CO₂ CO O₂

ZSU

Japanese type approval
SAS992-1 (SO₂ analyzer)
SAC992-1 (CO analyzer)
SAN991-1 (NO_x analyzer)
SE981 (zirconia O₂ analyzer)
SF011 (paramagnetic O₂ analyzer)



Features

- Double-beam NDIR
- Long-term superior stability
- Twin detectors for interference compensation
- Automatic calibration
- Space-saving design that enables the maintenance work from front side

Specifications

Target	Flue gas from incinerators and boilers
Measurable components	NO _x , SO ₂ , CO ₂ , CO, O ₂
Principle	Double-beam NDIR + zirconia or paramagnetic O ₂ sensor
Measurement range	NO _x : 0 ... 50 ... 5000 ppm
	SO ₂ : 0 ... 50 ... 5000 ppm
	CO ₂ : 0 ... 10% / 0 ... 20%
	CO: 0 ... 50 ... 5000 ppm
	O ₂ : 0 ... 10 vol% / 0 ... 25 vol%
Repeatability	±0.5% FS
Linearity	±1% FS
Zero drift	±2% FS per week (O ₂ : ±2% FS per month)
Span drift	±2% FS per week (O ₂ : ±2% FS per month)
Response time	NO _x , CO ₂ , CO, O ₂ : 2 min, SO ₂ : 4 min (for 90% response, from the analyzer inlet)
Output signal	4–20 mA DC
Contact output	During auto calibration, during maintenance, concentration alarm, CO peak count alarm, range identification, etc.
Contact input	Auto calibration start, range switchover, pump on/off, etc.
Functions	Auto calibration, O ₂ correction, O ₂ corrected average value, concentration alarm, CO peak count alarm, etc.
Display	Backlit LCD
Recorder	Paperless recorder (option)
Standard gas	Six 3.4L cylinders can be housed (option)
Power supply voltage	100, 110, 115, 200, or 230 V AC, 50/60 Hz
Dimensions	815 (W) × 1780 (H) × 700 (D) mm, outdoor use

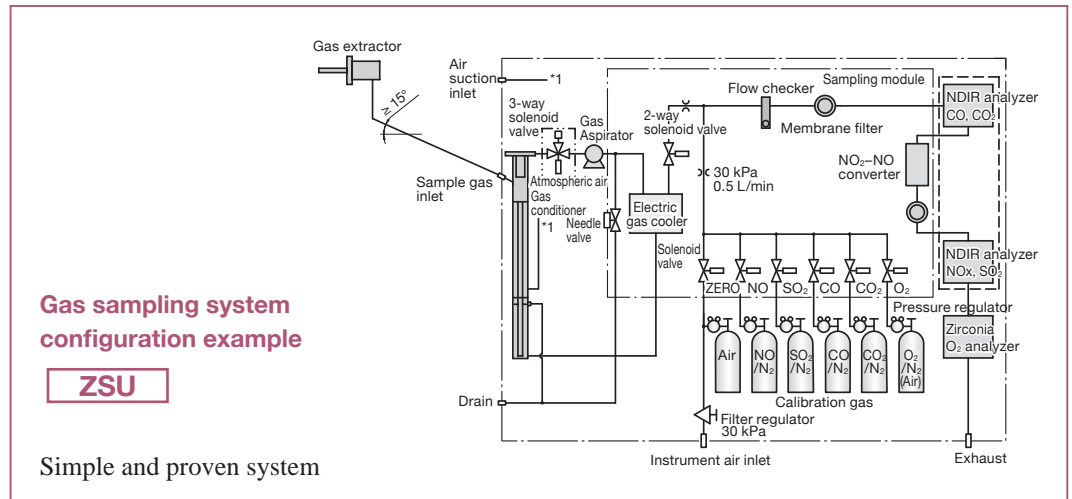

Simultaneous measurement of up to 7 components in flue gas

NOx SO₂ CO₂ CO O₂ HCl Dust

ZSU-7

Japanese type approval
 SAS992-1 (SO₂ analyzer)
 SAC992-1 (CO analyzer)
 SAN991-1 (NO_x analyzer)
 SE981 (zirconia O₂ analyzer)
 SF011 (paramagnetic O₂ analyzer)



Features

- Monitors up to 7 gas concentrations
- All the necessary equipment are housed in a space-saving cabinet
- Less electrical work because signal and power terminals are in one place
- Low-maintenance laser HCl analyzer
- 40% less power consumption compared to conventional models

Specifications

Target	Flue gas from incinerators and boilers
Measurable components	NO _x , SO ₂ , CO ₂ , CO, O ₂ , HCl, dust
Principle	NO _x , SO ₂ , CO ₂ , CO: NDIR O ₂ : zirconia HCl: laser Dust: electrostatic induction
Measurement range	NO _x : 0 ... 50 ... 5000 ppm SO ₂ : 0 ... 50 ... 5000 ppm CO ₂ : 0 ... 10% / 0 ... 20% CO: 0 ... 50 ... 5000 ppm O ₂ : 0 ... 10 vol% / 0 ... 25 vol% HCl: 0 ... 15 ... 5000 ppm Dust: 0.01 ... 1000 mg/m ³
Repeatability	±0.5% FS (NDIR), ±2% FS (laser)
Zero & span drift	±2% FS per week (NDIR) ±2% FS per 6 months (laser)
Response time	120 s (NDIR), 1 ... 5 s (laser)
Output signal	4–20 mA DC
Contact output	8 points (during maintenance, during auto calibration, analyzer abnormality, etc.)
Contact input	Auto calibration start, average value reset, measurement stop, etc.
Recorder	Paperless recorder (option)
Standard gas	Six 3.4L cylinders can be housed (option)
Power supply voltage	100 V AC, 50/60 Hz
Dimensions	1215 (W) × 1780 (H) × 700 (D) mm, outdoor use

For CO and O₂ monitoring in flue gas

CO O₂

ZSQ

Japanese type approval certified
 SAC984 (CO analyzer)
 SE981 (zirconia O₂ analyzer)



Features

- Single-beam NDIR
- Long-term superior stability
- CO peak count alarm
- Automatic calibration
- Space-saving design that enables the maintenance work from front side

Specifications

Target	Flue gas from incinerators
Measurable components	CO, O ₂
Principle	Single-beam NDIR + zirconia O ₂ sensor
Measurement range	CO: 0 ... 200 ... 2000 ppm O ₂ : 0 ... 25 vol%
Repeatability	±0.5% FS
Linearity	±1% FS
Zero & span drift	±2% FS per week (O ₂ : ±2% FS per month)
Response time	≤ 90 s (for 90% response, from the analyzer inlet)
Output signal	4–20 mA DC
Contact output	During calibration, during maintenance, concentration alarm, etc.
Functions	Auto calibration, O ₂ correction, O ₂ corrected average value, CO peak count alarm, etc.
Display	Backlit LCD
Recorder	Paperless recorder (option)
Standard gas	Three 3.4L cylinders can be housed (option)
Power supply voltage	100 V AC, 50/60 Hz
Dimensions	615 (W) × 1640 (H) × 765 (D) mm, outdoor use

NDIR Gas Analyzers

Single-beam **ZPA, ZPB, ZPG**
 NO_x SO₂ CO₂ CO CH₄ O₂

From low range (0–5 ppm) to 100%

Low-concentration measurement and drift-less measurement available



ZPA



ZPB



ZPG



Features

- Wide measurement range: from 0–5 ppm to 100%
- Excellent zero-point stability: $\pm 0.5\%$ FS per week (ZPB, ZPG)
- Simultaneous and continuous measurement of up to 5 components (ZPA, ZPB)
- Compact and lightweight: 483 (W) × 133 (H) × 382 (D) mm, ≤ 13 kg
- Simple structure for ease of maintenance
- Built-in magnetic or galvanic O₂ sensor (optional)

Minimum measurement range

Components	Standard type (ZPA)	Drift-less type (ZPB)	Low-concentration measurement type (ZPG)
NO	0 ... 200 ppm	0 ... 50 ppm	0 ... 10 ppm
SO ₂	0 ... 200 ppm	0 ... 50 ppm	0 ... 10 ppm
CO ₂	0 ... 100 ppm	0 ... 50 ppm	0 ... 5 ppm
CO	0 ... 200 ppm	0 ... 50 ppm	0 ... 5 ppm
CH ₄	0 ... 500 ppm	-	-
O ₂	0 ... 5%	0 ... 5%	0 ... 5%

Specifications

Type	Standard type		Drift-less type		Low-concentration measurement type	
Model	ZPA		ZPB		ZPG	
Principle	NDIR (single beam) O ₂ : magnetic, galvanic, or external zirconia analyzer					
Number of measurable components	Up to 5 (including O ₂)				Up to 2 (including O ₂)	
Measurable components and ranges	Min		Max		Min	
	Max		Min		Max	
NO	0 ... 200 ppm	0 ... 5000 ppm	0 ... 50 ppm	0 ... 5000 ppm	0 ... 10 ppm	0 ... 100 ppm
SO ₂	0 ... 200 ppm	0 ... 10 vol%	0 ... 50 ppm	0 ... 5000 ppm	0 ... 10 ppm	0 ... 100 ppm
CO ₂	0 ... 100 ppm	0 ... 100 vol%	0 ... 50 ppm	0 ... 25 vol%	0 ... 5 ppm	0 ... 50 ppm
CO	0 ... 200 ppm	0 ... 100 vol%	0 ... 50 ppm	0 ... 5000 ppm	0 ... 5 ppm	0 ... 50 ppm
CH ₄	0 ... 500 ppm	0 ... 100 vol%	-	-	-	-
O ₂ (built-in galvanic analyzer)	0 ... 10 vol%	0 ... 25 vol%	0 ... 10 vol%	0 ... 25 vol%	0 ... 10 vol%	0 ... 25 vol%
O ₂ (built-in magnetic analyzer)	0 ... 5 vol%	0 ... 100 vol%	0 ... 5 vol%	0 ... 100 vol%	0 ... 5 vol%	0 ... 100 vol%
O ₂ (external zirconia analyzer)	None	100 ... 95 vol%	-	-	-	-
O ₂ (external zirconia analyzer)	0 ... 5 vol%	0 ... 25 vol%	0 ... 5 vol%	0 ... 25 vol%	0 ... 5 vol%	0 ... 25 vol%
No. of measurement ranges	Up to 2 ranges per component					
Repeatability	$\pm 0.5\%$ FS					
Linearity	$\pm 1\%$ FS					
Zero drift	$\pm 2\%$ FS per week		$\pm 0.5\%$ FS per week			
Span drift	$\pm 2\%$ FS per week		$\pm 2\%$ FS per week			
Response time (for 90%)	10 s ... 30 s (Depending on measurement range)		≤ 30 s Dead time varies within 5–20 seconds according to the setting for the sample switching.			
Output signal	4–20 mA DC or 0–1 V DC (ZPA and ZPB: ≤ 12 points, ZPG: ≤ 4 points)					
Display	LED-backlit LCD, instantaneous value, O ₂ corrected instantaneous value, O ₂ corrected average value, O ₂ average					
Range switching	by key operation, automatic, or remotely (option)					
Contact input (option)	Voltage input: remote range-switching, auto-calibration remote start, remote hold, average reset					
Contact output (option)	SPDT relay contact: analyzer error, calibration error, range identification, during auto-calibration, solenoid valve operation for auto-calibration, H/L limit alarm, CO peak alarm					
Atmospheric pressure correction (option)	Provided as needed					
Standard functions	Output hold, auto/manual range switching					
Optional functions	Auto calibration, auto calibration remote start, remote output-hold, range identification contact output, H/L limit alarm, O ₂ correction, O ₂ -corrected average values, average resetting contact input, CO peak alarm contact output					
Communication (option)	RS-485 (Modbus)					
Sample gas flow checker	Not provided		Provided			
Gas inlet/outlet	Rc 1/4 or NPT 1/4 internal thread					
Purge gas flow rate	1 L/min					
Reference gas	Not required		Required (dry N ₂ or dry air)			
Operating environment	-20°C ... +60°C, RH 90% or lower (no condensation)					
Mounting	19-inch rack mount					
Power supply voltage	100–240 V AC, 50/60 Hz					
Power consumption	Approx. 100 VA		Approx. 120 VA		Approx. 100 VA	
Dimensions	483 (W) × 133 (H) × 382 (D) mm					
Weight	Approx. 11 kg		Approx. 13 kg		Approx. 11 kg	

Principle

Single-beam

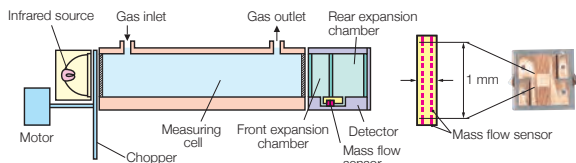

Double-beam

High-sensitivity sensor offers a maximum rangeability of 1 : 25

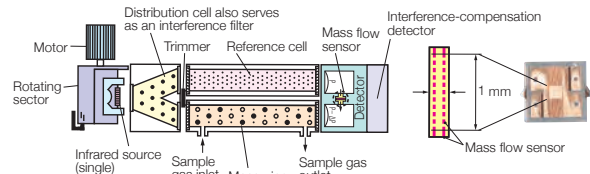

● Mass flow sensor

Converts the infrared absorption into an electrical signal. Excellent noise resistance thanks to the low impedance sensor. The absence of moving parts makes the device resistant to vibration and semi-permanently usable.

Hot-wire temperature

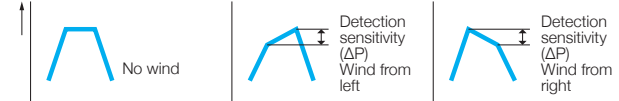

Principle The mass flow sensor measures the amount of infrared absorbed in the measurement cell.

Double-beam

ZKJ CE

NO_x SO₂ CO₂ CO CH₄ N₂O O₂

Simultaneous and continuous measurement of up to 5 components
Double-beamed and high-performance model

Features

- Simultaneous and continuous measurement of up to 5 components
- Hardly affected by interference from other gases
- Superior functionality—calibration, alarm, calculation
- Easy-to-see LCD
- Maximum range ratio of 1 : 25
- Excellent zero-point stability: ±1% FS per week

Measurement range

Component	Minimum range	Maximum range
NO	0 ... 50 ppm	0 ... 5000 ppm
SO ₂	0 ... 50 ppm	0 ... 10 vol%
CO ₂	0 ... 20 ppm	0 ... 100 vol%
CO	0 ... 50 ppm	0 ... 100 vol%
CH ₄	0 ... 200 ppm	0 ... 100 vol%
N ₂ O	0 ... 200 ppm	0 ... 2000 ppm
O ₂	0 ... 5 vol%	0 ... 25 vol%



Specifications

Principle	NO, SO ₂ , CO ₂ , CO, CH ₄ , N ₂ O: NDIR (double-beam) O ₂ : built-in paramagnetic sensor or external zirconia analyzer
Repeatability	±0.5% FS (±1% FS for the ranges below 50 ppm)
Linearity	±1% FS
Zero drift	±1% FS per week (±2% FS per week for 50–200 ppm range)
Span drift	±2% FS per week (±2% FS per day for the ranges below 50 ppm)
Response time (for 90%)	≤ 60 s
Output signal	4–20 mA DC or 0–1 V DC, up to 12 points
Contact input	Volt-free contact: remote range-switching, auto-calibration remote start, remote hold, average reset, pump on/off
Contact output	SPST-NO and SPDT contact: analyzer error, calibration error, range identification, during auto-calibration, pump on/off, CO peak alarm, H/L limit alarm, power interruption
Communication (option)	RS-232C (Modbus)
Display	LED-backlit LCD, instantaneous value, O ₂ corrected instantaneous value, O ₂ corrected average value, O ₂ average
Power supply voltage	100–240 V AC, 50/60 Hz
Power consumption	250 VA
Dimensions and weight	483 (W) × 177 (H) × 600 (D) mm, approx. 22kg

NDIR Gas Analyzer for Heat Treatment Furnace

For optimal quality management

ZFG
CO₂ CO CH₄



Features

- High-accuracy with a repeatability of 0.5% FS
- Single-beam system: long-term stability and low maintenance
- Monitors concentration of CO₂, CO, CH₄ that correlate Carbon Potential (CP)
- CP calculation available (option)
- Simultaneous and continuous monitoring of CO₂ + CO, CH₄ + CO, CO₂ + CH₄
- Compact and lightweight
About one-third volume and half weight of previous models ZAR and ZFU
- Panel mounting with cutout size of 206 (W) × 173 (H) mm

Specifications

Components	CO ₂ , CO, CH ₄
Principle	Single-beam NDIR
Measurement range	CO ₂ : 0 ... 0.5 ... 100%
	CO: 0 ... 0.5 ... 100%
	CH ₄ : 0 ... 1 ... 10%
No. of components	≤ 2
No. of ranges	≤ 2 for each component
Repeatability	±0.5% FS
Zero and span drift	±2% FS per week

Response time (for 90%)	≤ 10 s
Output signal	4–20 mA DC, 0–1 V DC, 0–100 mV DC, or 0–10 mV DC
Contact output	Analyzer error, range identification
Contact input (option)	Remote range-switching, remote hold
Standard functions	Output hold, automatic light-off, analyzer error
Optional functions	CP calculation, etc.
Display	Backlit LCD
Power supply voltage	100–240 V AC, 50/60 Hz
Dimensions and weight	218 (W) × 211 (H) × 257 (D) mm, approx. 5 kg

NDIR CO₂ Controller

ZFP9 CE
CO₂



Features

- Wall mount type with built-in pump and filter
- Applications: protected horticulture, ventilation systems for buildings, controlled atmosphere storage facilities

Specifications

Target	CO ₂ in air
Principle	Single-beam NDIR
Measurement range	0 ... 0.2 ... 20%
Repeatability	±1% FS
Zero drift	±10% per 6 months
Response time (for 90%)	≤ 10 s
Gas sampling	Suction pump and filter
Power supply voltage	100 V, 115 V, 200 V, or 220 V AC, 50/60 Hz
Dimensions and weight	220 (W) × 257 (H) × 85 (D) mm, approx. 3 kg

Biomass Gas Analyzer

ZPAF CE
CH₄ CO₂ H₂S
O₂



Components and ranges

	1st range	2nd range	Principle
CH ₄	0...20 vol %	0...100 vol %	Single-beam NDIR
CO ₂	0...20 vol %	0...100 vol %	
H ₂ S	0...500 ppm	0...2000/5000 ppm	Constant-potential electrolytic
O ₂	0...10 vol %	0...25 vol %	Galvanic fuel cell

Specifications

Repeatability	±0.5% FS (H ₂ S: ±2.0% FS)
Linearity	±1.0% FS (H ₂ S: ±2.0% FS)
Zero drift	±2% FS per week
Span drift	±2% FS per week (H ₂ S: ±2.5% FS per week or ±5% FS per day)
Response time (for 90%)	10–30s (H ₂ S: 180s)
Output	4–20mA DC or 0–1V DC
Contact input	12–24V DC, ≤ 9 points
Contact output	SPDT, ≤ 15 points
Communication (option)	RS-485 (Modbus)
Display	Backlit LCD
Power supply voltage	100–240 V AC, 50/60 Hz
Dimensions and weight	483 (W) × 133 (H) × 382 (D) mm, approx. 9 kg

Compact NDIR Gas Analyzer

With gas sampling devices accommodated

Simultaneously and continuously monitors up to 5 components among NO_x, SO₂, CO₂, CO, CH₄, and O₂

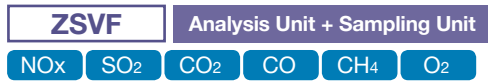

Features

- Analysis unit and sampling unit can be separated for ease of move and installation
- Suited to monitoring of flue gas, combustion gas, biogas, etc.



Sampling unit

Analysis unit

- No installation work
- Interactive interface

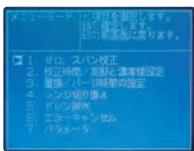

Menu screen

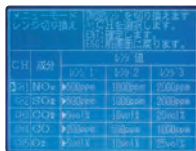

Range switching screen

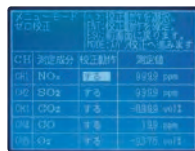

Zero/span calibration

- CP calculation available
The IR analyzer can ensure higher CP traceability than the zirconia O₂ analyzer because the IR analyzer simultaneously measures CO and CO₂ to calculate CP.
- Easy to maintenance
Automatic water-discharge

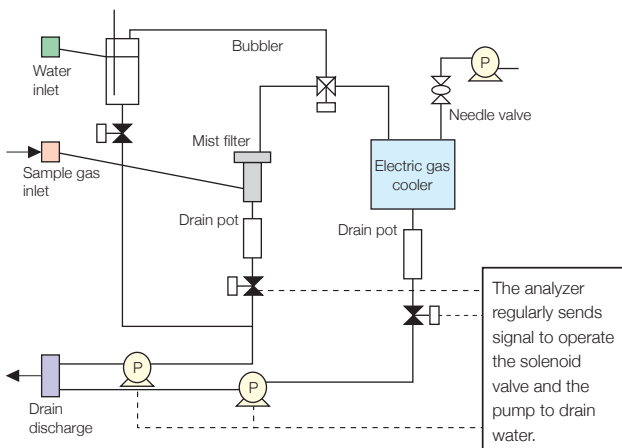

Specifications

Measurable components	NO _x , SO ₂ , CO ₂ , CO, CH ₄ , O ₂
Principle	Single-beam NDIR + galvanic or paramagnetic O ₂ sensor
Measurement range	NO _x : 0 ... 500 ... 5000 ppm
	SO ₂ : 0 ... 500 ppm ... 1%
	CO ₂ : 0 ... 200 ppm ... 100%
	CO: 0 ... 200 ppm ... 100%
	CO ₄ : 0 ... 1000 ppm ... 100%
O ₂ : 0 ... 5/10/25%	
Repeatability	±0.5% FS
Output signal	4–20 mA DC or 0–1 V DC Instantaneous value, O ₂ converted instantaneous value, O ₂ converted average value, CP calculation
Communication	RS-232C (Modbus)
Power supply voltage	100–115 V AC or 200–240 V AC, 50/60 Hz
Dimensions	Analysis unit: 365 (W) × 211 (H) × 514 (D) mm Sampling unit: 365 (W) × 377 (H) × 514 (D) mm
Weight	Analysis unit: approx. 12 kg Sampling unit: approx. 18 kg
Gas extractor (option)	Fixed type with flange, or unfixed type

Simultaneously and continuously measures up to 4 components among CO₂, CO, CH₄, and O₂



Features

- Portable type with built-in pump, filter, and flowmeter
- CP calculation, O₂ correction, O₂ corrected average
- Easy-to-see LCD
- Single-beam system: long-term stability and low maintenance

Specifications

Components	CO ₂ , CO, CH ₄ , O ₂
Principle	Single-beam NDIR + Galvanic O ₂ sensor
Measurement range	CO ₂ : 0 ... 200 ppm ... 100%
	CO: 0 ... 200 ppm ... 100%
	CO ₄ : 0 ... 1000 ppm ... 100%
	O ₂ : 0 ... 5/10/25%
Repeatability	±0.5% FS
Zero drift	±1% FS per day
Span drift	±1% FS per day
Response time (for 90%)	≤ 50 s
Output signal	4–20 mA DC or 0–1 V DC
Communication	RS-232C (Modbus)
Standard functions	CP calculation, O ₂ correction, O ₂ corrected average, automatic light-off
Display	Backlit LCD
Power supply voltage	100–115 V AC or 200–240 V AC
Dimensions	365 (W) × 211 (H) × 527 (D) mm

Laser Gas Analyzer

Insertion type offers high-speed measurement
Long-term stability and low maintenance



Features

- Fast response with no sampling system
- Semiconductor laser ensures high precision and accuracy

Measurable components

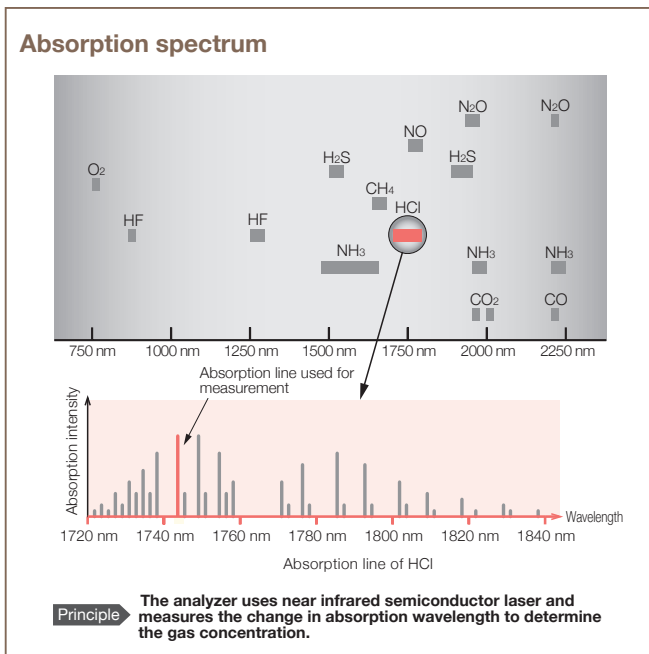
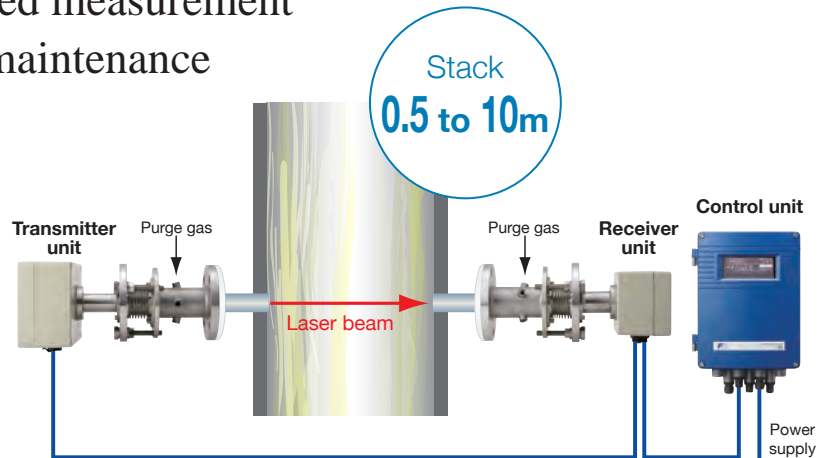

Fast response within 2 seconds

Compared to the ion electrode (sampling) method, the direct measurement provides remarkably faster response.

Comparison with sampling system

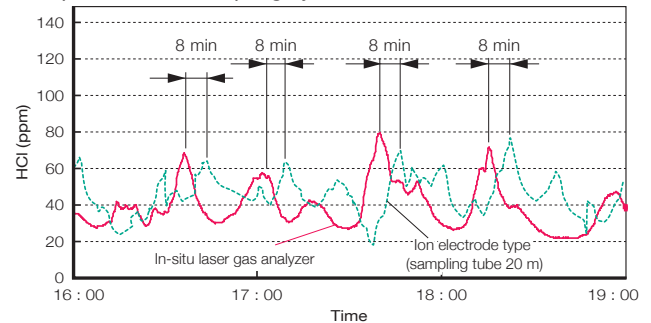

CO + O₂ analyzer available

Simultaneous measurement of CO and O₂ enables precise control of air-fuel ratio while reducing the cost of installation and maintenance.

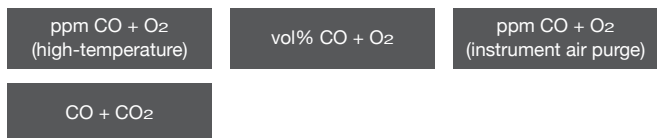

Instrument air purge available

O₂ analyzer for combustion control accepts instrument air purge.

Zero point stability: ±2.0% FS per 6 months

Purge system reduces the risk of zero drift due to contamination

Energy saving and low maintenance

Energy consumption ≤ 80 VA
Maintenance work ≤ twice a year
With no need for sampling devices and preconditioning, consumable parts and maintenance work are greatly reduced.



Specifications

General

Principle	Non-dispersive infrared (NDIR)
Method	Cross-stack
Measurable components and ranges	See the table below
Light source	Near-infrared semiconductor laser
Laser class	CLASS 1 (O ₂ analyzers of high-temperature version and instrument air purge version fall under CLASS 3B)
Power supply voltage	100–240 V AC, 50/60 Hz
Power consumption	80 VA
Calibration interval	every 6 months (depending on the operating environment)
Display	Backlit LCD
Display contents	Component, concentration (instantaneous value, average, O ₂ corrected instantaneous value, O ₂ corrected average value), alarm
Weight	Receiver unit and transmitter unit: approx. 10 kg each, control unit: approx. 8 kg
Dimensions (D × W × H)	Receiver unit (400 × 180 × 155 mm) Receiver unit (400 × 240 × 160 mm) Control unit (137 × 255 × 440 mm)
IP rating	IP65

Performance

Response	≤ 4 s (≤ 2 s in high-speed version)
Repeatability	±1.0% FS (depending on components and ranges) CO + O ₂ measurement: ±2% FS
Linearity	±1.0% FS (depending on components and ranges) CO + O ₂ measurement: ±3% FS
Zero drift	±2.0% FS per 6 months (depending on component and range) CO + O ₂ measurement: ±4% FS per 6 months
Interference effect	±2.0% FS
Detection limit	1% of minimum range

Measurable components and ranges

	Measurable components		Min. range*	Max. range*	Gas temperature	Purge gas	4th code
Single beam 1-component analyzer	HCl		10 ppm	5000 ppm	≤ 400°C	Instrument air	C
	NH ₃		15 ppm	5000 ppm	≤ 450°C		W
	CO (high range)		2.0 vol%	100 vol%	≤ 300°C		A
	CO (low range)		200 ppm	1 vol%	≤ 400°C		M
	CO ₂		2.0 vol%	100 vol%	≤ 300°C		G
	CH ₄		100 ppm	100 vol%	≤ 300°C		R
	O ₂		10 vol%	100 vol%	≤ 300°C	N ₂	P
	O ₂ (high temperature)		4 vol%	100 vol%	≤ 1200°C		Q
	O ₂ (instrument air purge)		25 vol%	100 vol%	400°C ... 1200°C		Instrument air
Single beam 2-component analyzer	CO + CO ₂		2.5 vol%	100 vol%	≤ 300°C	Instrument air	K
Double beam 2-component analyzer	ppm CO + O ₂ (instrument air purge)	CO	200 ppm	2 vol%	400°C ... 1200°C	Instrument air	V
		O ₂	25 vol%	100 vol%			
	ppm CO + O ₂ (high temperature)	CO	200 ppm	2 vol%	≤ 1200°C	N ₂	U
		O ₂	5 vol%	50 vol%			
	vol% CO + O ₂	CO	2 vol%	50 vol%	≤ 300°C		S
		O ₂	10 vol%	100 vol%			

*The measurement ranges described above are for the optical path of 1 m.

Input/output signal

Analog output	4–20 mA DC or 1–5 V DC, 2 or 4 points Measured value and O ₂ corrected value. Switchable between instantaneous value and average value
Analog input	4–20 mA DC, 2 points Sample gas pressure, temperature, velocity, O ₂ concentration, water concentration, air purge pressure *Inputs are used for compensating concentration, O ₂ correction, and alarm output.
Digital output	Relay contact output, 6 points Low light transmission, H/L limit alarm, analyzer error, during calibration / during hold, power interruption, environmental error
Digital input (option)	Voltage input received by photocoupler, 3 points Average value reset, switchover between instantaneous value and moving average value, remote hold

Installation environment

Ambient temperature	–20 to +55°C (Receiver unit, transmitter unit) –5 to +45°C (Control unit)
Ambient humidity	≤ 90% RH
Optical path length	0.5 to 10 m (0.5 to 5 m in CO + O ₂ measurement)
Standard flange	JIS10K, 50A or 100A
Purge gas	See the table below. Purge gas pressure: ≥ 0.3 MPa
Purge gas flow rate	≥ 20 L/min
Gas conditions	See the table below Moisture: ≤ 50 vol% (no condensation) Pressure: ±10 kPa (Consult us for pressure above the limit.) Dust: Standard version: ≤ 5 g/m ³ (N) Dust resistant version: ≤ 20 g/m ³ (N)

Zirconia Oxygen Analyzers

Fast response with no need for gas sampling devices
Ideal for combustion control in boilers and incinerators

Principle

The analyzer makes use of the property of zirconium oxide that conducts oxygen ion when heated. The analyzer can obtain O₂ concentration by sensing the electromotive force arises from the difference of O₂ concentration between air and the sample gas.

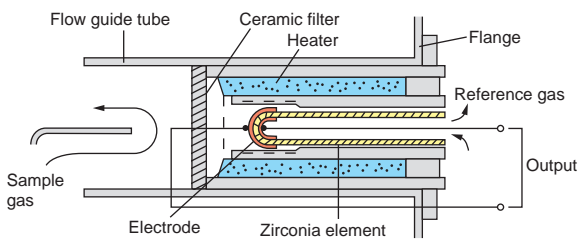

Easily replaceable zirconia element

*Excluding ZSB



Fast response (4–7 seconds)
HART communication available

O₂



IP66

Converter
ZKMA



IP67

Converter
ZKMB



Flow guide tube

Detector ZFK8



Features

- Easily replaceable zirconia element
- Fast response (4–7 seconds)
- IP66 or IP67 enclosure
- RS-485 or HART communication

Specifications

Target	O ₂ in incombustible gas
Principle	Insertion type zirconia sensor
Range	0 ... 2 ... 50 vol% O ₂ (user configurable)
Repeatability	±0.5% FS
Linearity	±2% FS
Response time (for 90%)	4 s ... 7 s
Output signal	4–20 mA DC or 0–1 V DC
Contact output	6 points, SPST-NO contact: H/L limit alarm, during maintenance, during blowdown, during calibration, analyzer error
Contact input	3 volt-free contacts: selection from 7 items
Display	Backlit LCD
Communication	RS-485 (Modbus) or HART
Optional functions	Combustion efficiency display, blowdown, auto calibration, cock (selector valve), flowmeter
Converter installation	Panel mount or pipe mount
Cable length between converter and detector	≤ 100m
Power supply voltage	100–120 V AC or 200–240 V AC, 50/60 Hz

Flameproof type for hazardous applications

O₂

Converter ZKME



Flow guide tube for high particulate

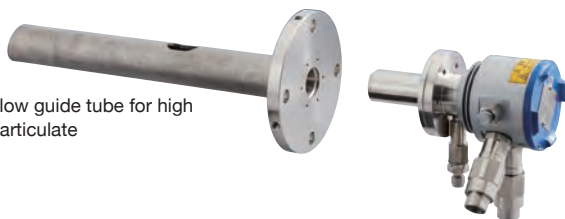

Detector ZFKE

Features

- Easily replaceable zirconia element
- Fast response (4–7 seconds)
- TIIS and NEPSI certified

Specifications

Target	O ₂ in incombustible gas
Principle	Insertion type zirconia sensor
Range	0 ... 2 ... 50 vol% O ₂ (user configurable)
Repeatability	±0.5% FS
Linearity	±2% FS
Response time (for 90%)	4 s ... 7 s
Output signal	4–20 mA DC or 0–1 V DC
Contact output	6 points, SPST-NO contact: H/L limit alarm, during maintenance, during blowdown, during calibration, analyzer error
Contact input	3 volt-free contacts: selection from 7 items
Display	Backlit LCD
Communication	RS-485 (Modbus)
Optional functions	Combustion efficiency display, blowdown, auto calibration, cock (selector valve), flowmeter
Converter installation	Panel mount
Cable length between converter and detector	≤ 100 m
Power supply voltage	100–120 V AC or 200–240 V AC, 50/60 Hz

Integrated system

O₂



ZSB

Features

- Auto calibration and manual/auto blowdown
Solenoid valve and other necessary equipment are included
- User configurable range within 2 ... 50%
- Incomplete combustion indicator appears when O₂ is deficient

Specifications

Target	O ₂ in incombustible gas
Principle	Insertion type zirconia sensor
Range	0 ... 2 ... 50 vol% O ₂ (user configurable)
Repeatability	±0.5% FS
Linearity	±2% FS
Response time (for 90%)	4 s ... 7 s
Output signal	4–20 mA DC or 0–1 V DC
Contact output	6 points, SPST-NO contact: H/L limit alarm, during maintenance, during blowdown, during calibration, analyzer error
Contact input	3 volt-free contacts: selection from 7 items
Display	Backlit LCD
Communication	RS-485 (Modbus)
Installation	Self-standing or wall-mounting
Cable length between converter and detector	≤ 20 m
Power supply voltage	100–120 V AC, 50/60 Hz

Paramagnetic Oxygen Analyzers

Fast response unaffected by combustible gas

Ideal for combustion control in industrial furnaces and incinerators

Fast response within 2 seconds
Tolerant to interference

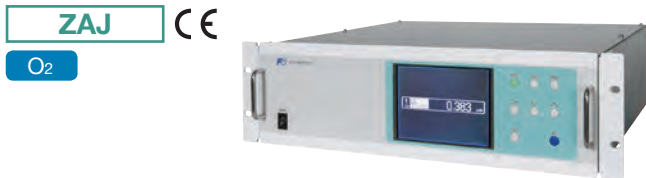

Principle

When the sample gas is placed in a magnetic field, oxygen molecules will be attracted. This gives rise to a pressure, which is detected by a mass flow sensor.

Interference effects (ZAJ)

Background gas (100%)	Zero drift (%)
NO	+43
CO	+0.01
CO ₂	-0.27
CH ₄	-0.20

He	+0.30
H ₂	+0.24
HCl	-0.30
NH ₃	-0.26
SO ₂	-0.22
N ₂ O	-0.02
H ₂ O	-0.02

Features

- Fast response within 2 seconds
- Tolerant to interference from other gas (H₂, CO₂, etc.)
- Suppressed ranges available (e.g. 21–100%O₂)
- No moving parts—low maintenance
- Automatic calibration, communication (option)

Specifications

Principle	Paramagnetic (pressure detection)
Measurement range	When reference gas is N ₂ : 0 ... 0.5 ... 100% O ₂ (configurable)
	When reference gas is air: 21 ... 23 ... 100% O ₂
	When reference gas is 100% O ₂ : 100 ... 98 ... 0% O ₂ (configurable)
No. of ranges	2
Repeatability	±1% FS
Linearity	±1% FS
Response time (for 90%)	≤ 2 s
Output signal	4–20 mA DC
Contact output (option)	6 SPST-NO contacts: during calibration, etc. 4 SPDT contacts: H/L alarm, etc.
Contact input (option)	Remote range-switching, remote hold
Display	Backlit LCD
Communication (option)	RS-485 (Modbus)
Installation	19" rack or panel mounting, or benchtop
Power supply voltage	85–264 V AC, 50/60 Hz

Dumbbell type requires no reference gas
Tolerant to interference



Principle

Oxygen molecules in sample gas are attracted by magnetic fields, and this gives rise to force works on the dumbbell. As the force is proportional to oxygen concentration, the analyzer converts it into an electric signal.

Interference effects (ZKG)

Background gas	Concentration	Zero drift (%)
NO	2000 ppm	+0.15
CO	100%	+0.1
CO ₂	100%	-0.35
CH ₄	100%	-0.25

Features

- Fast response within 15 seconds
- Hardly affected by interference from other gases (e.g. H₂, CO₂)
- No need for reference gas

Specifications

Principle	Paramagnetic (dumbbell type)
Range	0 ... 10, 21, 25, 50, 100% O ₂
No. of measurement ranges	1 or 2
Repeatability	±0.5% FS
Linearity	±1.0% FS
Response time (for 90%)	≤ 15 s
Output signal	4–20 mA DC, 0–1 V DC, or 0–10 mV DC
Display	LED (red)
Installation	Panel mounting
Power supply voltage	100–240 V AC, 50/60 Hz
Dimensions	190 (W) × 240 (H) × 234 (D) mm

Thermal Conductivity Gas Analyzer

Reliable and continuous measurement of H₂, He, Ar, etc.
Easy-to-see LCD

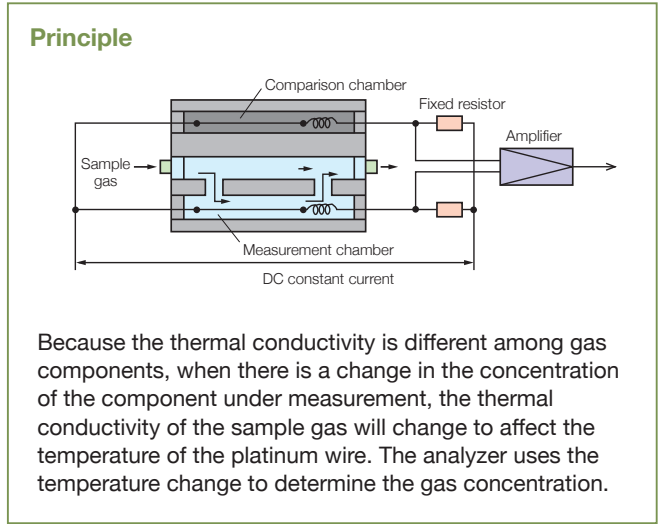
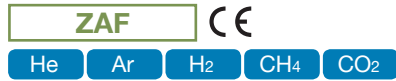

Features

- Easy-to-see LCD
- RS-232C Modbus (option)
- Auto calibration (option)
- Interference compensation (option)
- Concentration alarm output (option)
- Two switchable ranges (option)

Specifications

Principle	Thermal conductivity
Components	He, Ar, H ₂ , CH ₄ , CO ₂
Measurement range	Depends on components and ranges
Repeatability	±1% FS
Linearity	±2% FS
Response time (for 90%)	≤ 60 s (standard), ≤ 10 s (fast response version)
Output signal	4–20 mA DC, 0–1 V DC, or 0–10 mV DC
Contact output (option)	5 SPST-NO contacts: during calibration, H/L alarm, etc.

Contact input (option)	3 volt-free contacts; output hold, range switching, auto-calibration start
Display	Backlit LCD
Communication (option)	RS-232C
Mounting	Panel mounting
Power supply voltage	100–240 V AC, 50/60 Hz
Dimensions	192 (W) × 240 (H) × 213 (D) mm
Weight	Approx. 5 kg

Measurable components and ranges

Sample gas	Reference gas*1	Measurement range	Maximum range ratio
H ₂	N ₂ , (CO ₂ , Ar, He)	0 ... 3, 5, 10, 20, 50, 80, 100% 100 ... 90%, 100 ... 80%	1 : 10
He	N ₂ , (CO ₂ , Ar), O ₂ , Air	0 ... 5, 10, 20, 30, 40, 50, 80, 100% 100 ... 90%, 100 ... 80%	1 : 10
Ar	N ₂ , O ₂ , Air, (He)	0 ... 10, 20, 50, 80, 100% 100 ... 90%, 100 ... 80%	1 : 5
CH ₄	N ₂ , (CO ₂ , Ar, He)	0 ... 20, 40, 50, 60, 80, 100% 100 ... 80%	1 : 5
CO ₂	N ₂ , O ₂ , Air, (He)	0 ... 10, 20, 50, 100% 100 ... 90%	1 : 5

*1: Those in parenthesis need consultation. Measurement of H₂ included in O₂ is not available.

NDIR Gas Analyzers for Replacement

New models with equal size and functionality to predecessors

ZRG



ZKJ7



Features

- Simultaneously and continuously monitors up to 3 components among NO_x, SO₂, CO₂, CO, O₂
- Tolerant to interference
- Easy-to-see backlit LCD

ZRG3



ZPG3

CE



Features

- Sample switching system offers improved zero-stability
- Simultaneously and continuously monitors up to 2 components among NO_x, SO₂, CO₂, CO, O₂
- Tolerant to interference
- Easy-to-see backlit LCD

ZRH



ZPAH

ZPA1



Features

- Vertical and horizontal structures
- Continuously monitors 1 component among SO₂, CO₂, CO, CH₄ or 2 components of CO₂ + CO simultaneously
- Tolerant to interference
- Easy-to-see backlit LCD



ZRJ



ZPAJ



Features

- Simultaneously and continuously monitors up to 4 components among NO_x, SO₂, CO₂, CO, CH₄, and O₂
- Tolerant to interference
- Easy-to-see backlit LCD

Gas Sampling Devices

Gas Extractor

ZBA

Samples target gas from stack
Up to 1300°C



Gas Filter

ZBB

Removes dust and/or mist



Gas Cooler

ZBC

Gas Dryer

ZBJ

Removes moisture and heat from sample gas



Flowmeter and Pressure Regulator

ZBD

Flowmeters is used to check the flow rate of sample gas. Pressure regulator controls the pressure of standard gas.



Valves

ZBF

Controls sample gas flow



Gas Aspirator

ZBG

Durable and corrosion-resistant pump that draws the sample gas into the analyzer



Draining

ZBH

Discharges water



Gas Converter

ZDL CE

Converts NO_x contained in sample gas into NO

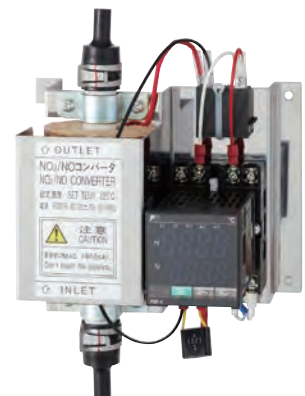

Applications

1 Refuse Incineration Plants

Gas analyzers are necessary for continuous emission monitoring required by laws and regulations; furthermore, they enable optimal combustion control.

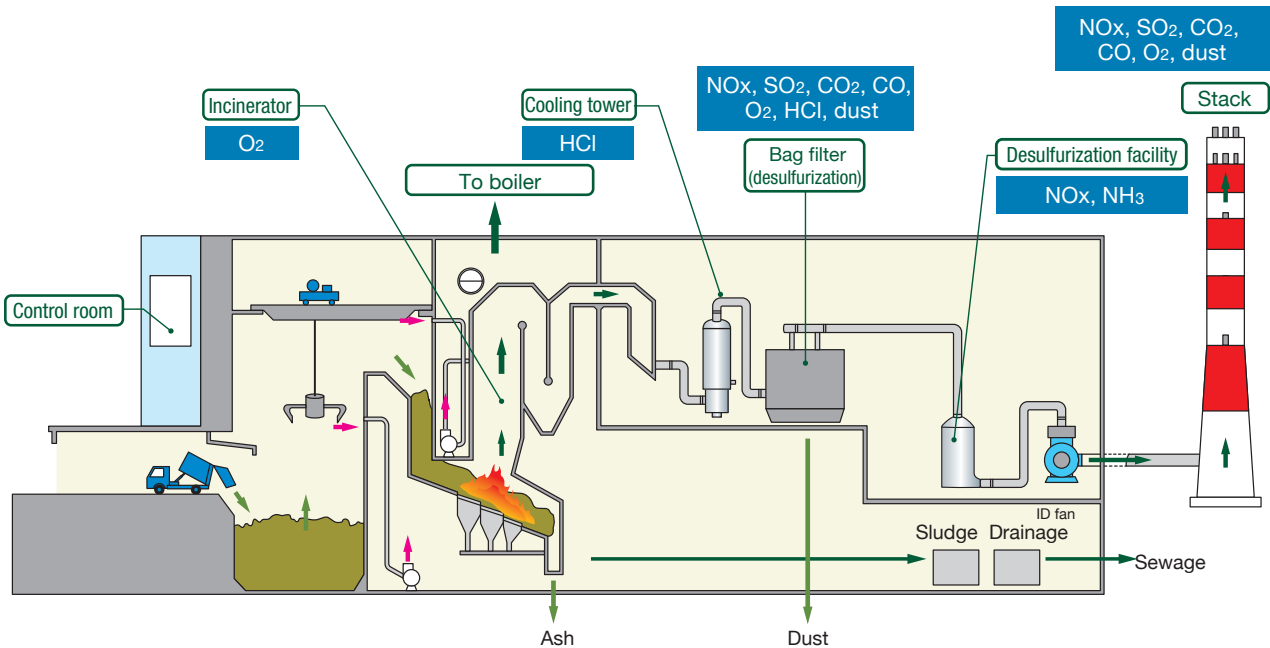

2 Large Industrial Boilers

Gas analysis enables optimal combustion control of boilers, which leads to reduction of both the fuel cost and pollutant.

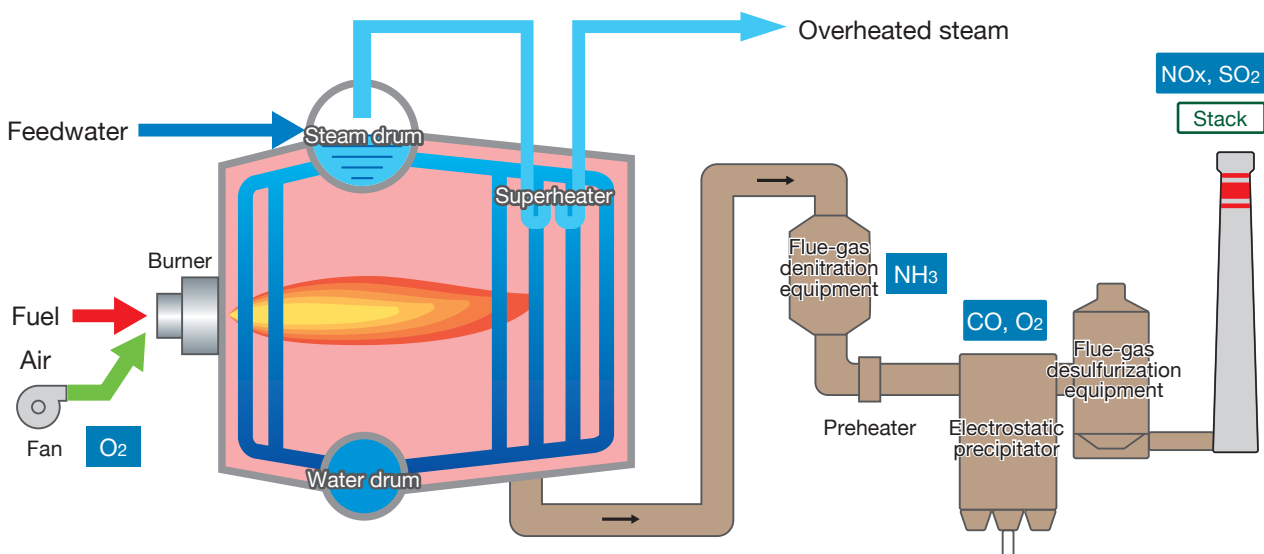

3

Converter Furnaces in Steelmaking Process

Monitoring the concentration of CO₂, CO, O₂, and H₂ can ensure the recovery of converter gas that can be reused as fuel.

It also enables oxygen amount control and decarburizing status check, which can lead to quality management of molten steel.

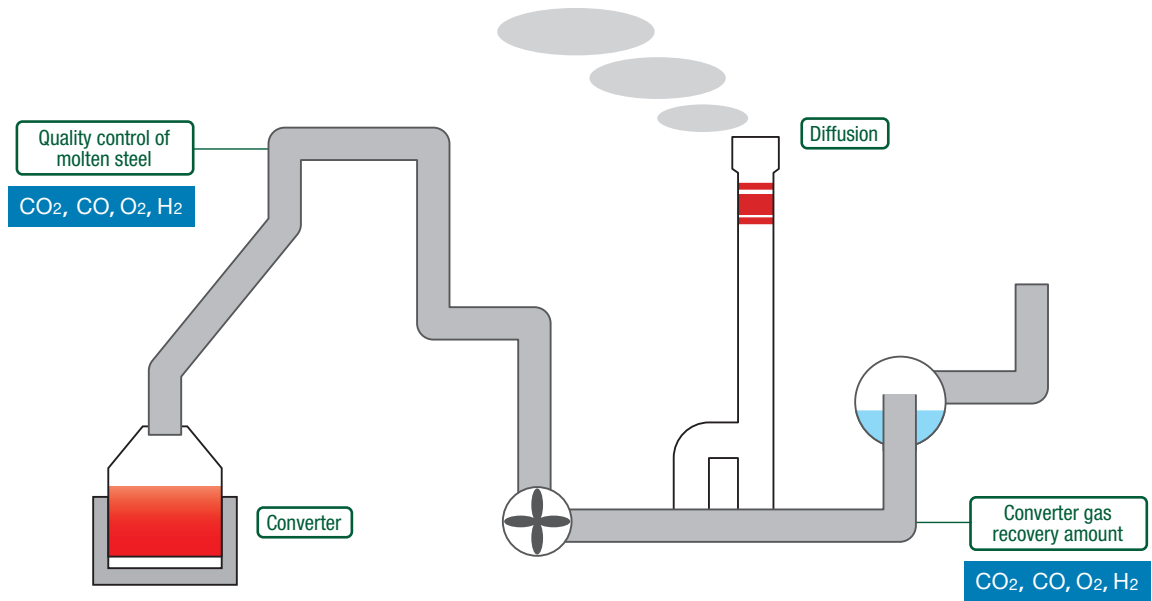

4

Heat Treatment Furnaces

Gas analyzers monitor the components relate to CP (carbon potential), such as CO₂, CO, CH₄, NH₃, H₂, and O₂, through which reliable quality control is achieved.

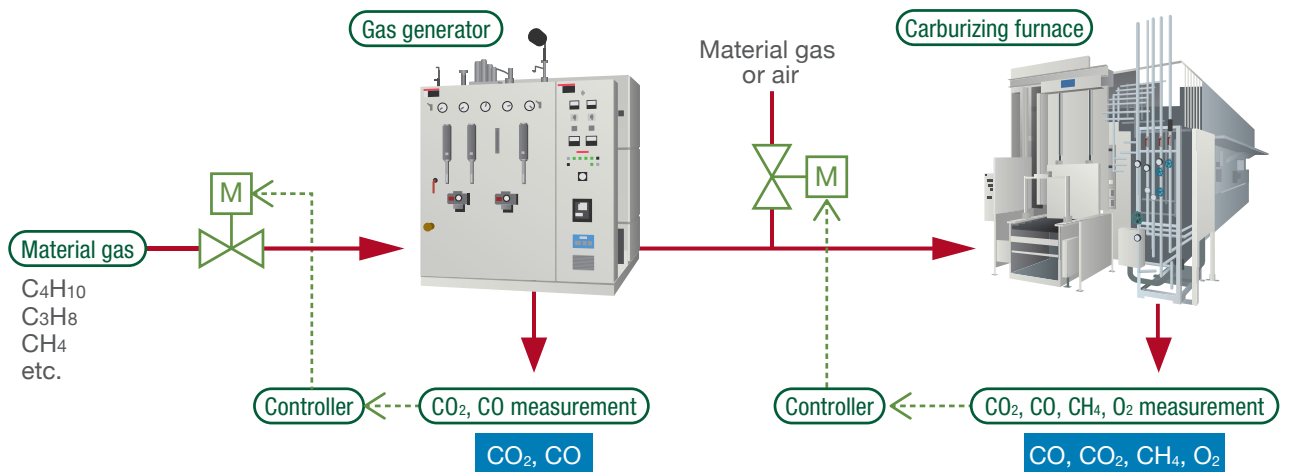

Satisfactory products for customers will be delivered under strict quality control.



Japanese Measurement Law:
Designated Manufacturing Business
Operator (No. 391901)

■ ISO 14001
Certificate No. EC97J1059
Tokyo Factory

■ ISO 9001
Certificate No. JMI-0122
Tokyo Factory

Find out more about our gas analyzers.



Gas Analyzers - Fuji Electric

www.fujielectric.com/products/instruments/products/anlz_gas/top.html

Information in this catalog is subject to change without notice.
Read the instruction manuals thoroughly before using the products.

FE Fuji Electric Co., Ltd.

www.fujielectric.com

Instrumentation & Sensors Planning Dept.

Gate City Ohsaki, East Tower, 11-2, Osaki 1-chome, Shinagawa-ku, Tokyo 141-0032, Japan

Phone: +81-3-5435-7021 Fax: +81-3-5435-7475

www.fujielectric.com/products/instruments/